

Topic 12: Action Potentials & Hodgkin-Huxley model  
(chapter 17 in book)

## Outline:

---

- What is the circuit diagram for the membrane?
- What governs the dynamics of the membrane potential?
- What is necessary to generate travelling voltage spikes?
- The necessity for a bi-stable system to generate action potentials
- A feeling for the Hogkin-Huxley model

## Wiring of neurons:

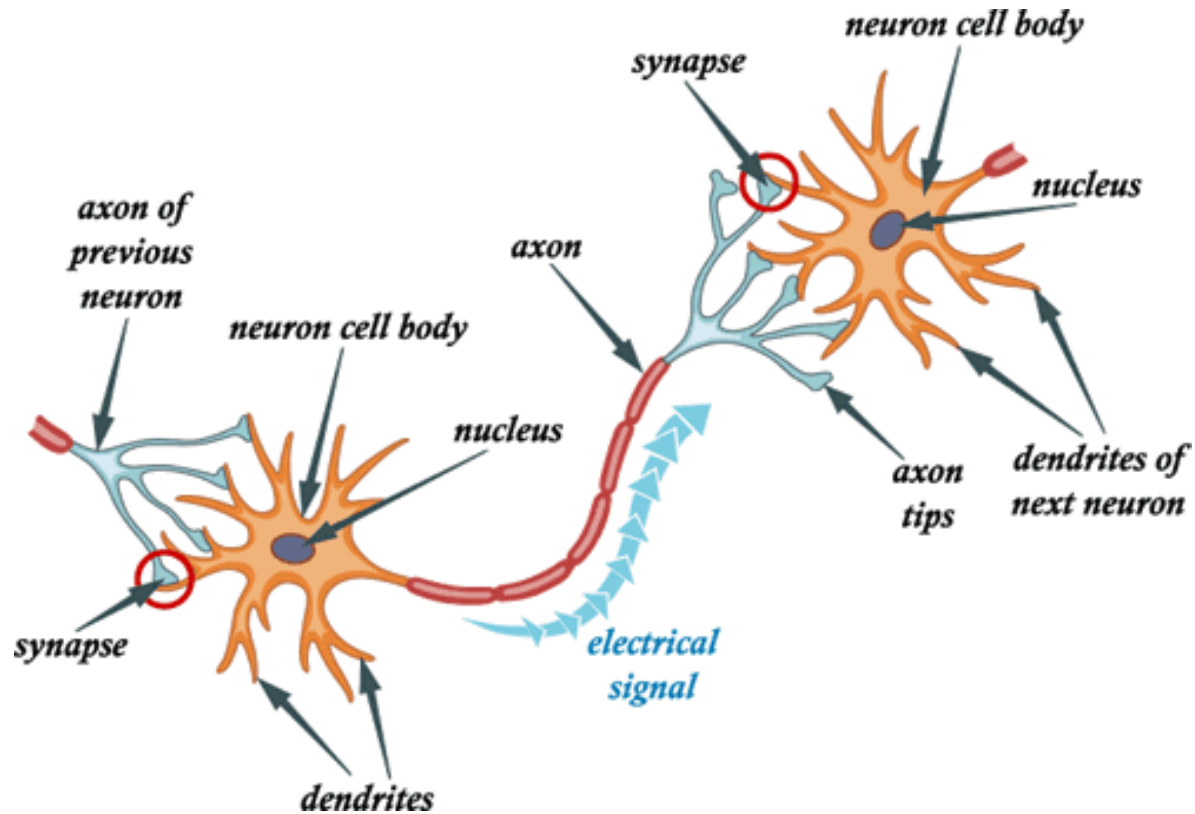

Neurons are wired to gether - axons to dendridites

Electrical signals (voltage pulses) are transmited along the axon

These trigger signalling events at synapses

# Measuring the action:

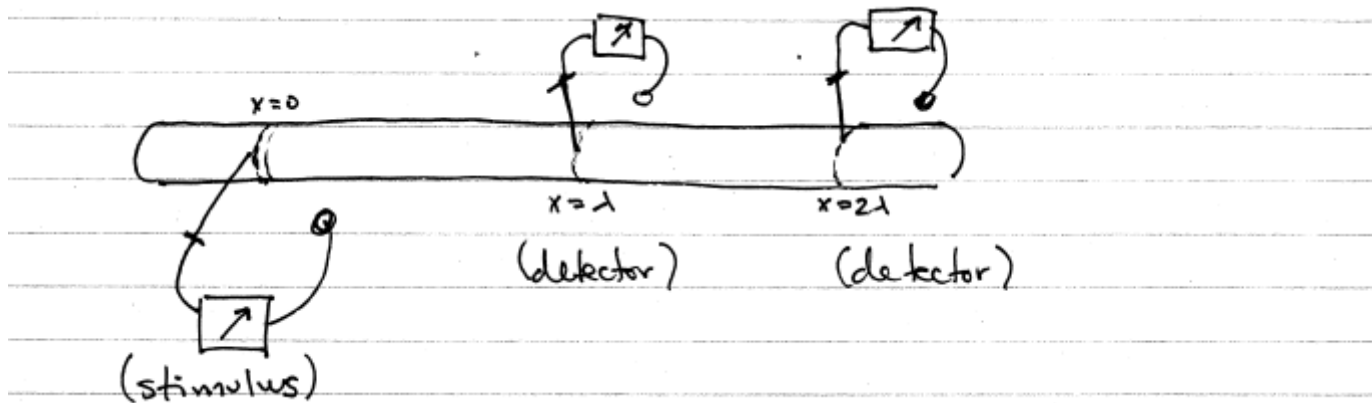

Recall, that for an axon at rest, the rest potential  $dV < 0$

A patch of membrane can be stimulated, "depolarizing" the membrane making  $dV$  less negative

Experimentally: can detect the propagation of this stimulus down the axon

For weak stimulus the response looks like a spreading & decaying wave –  
→ NOT an action potential

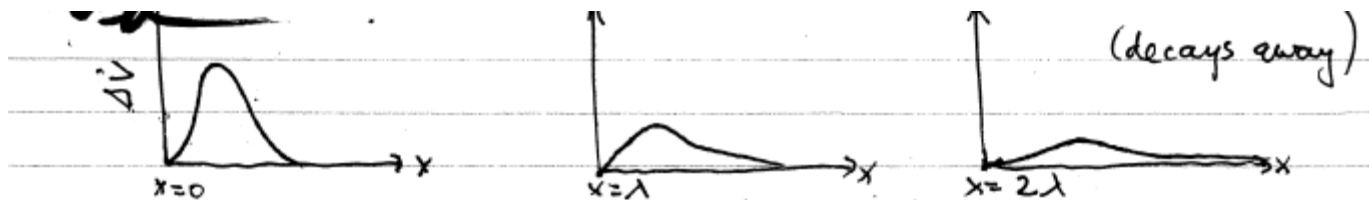

= electrotonus

# Anatomy of a nerve impulse – action potential:

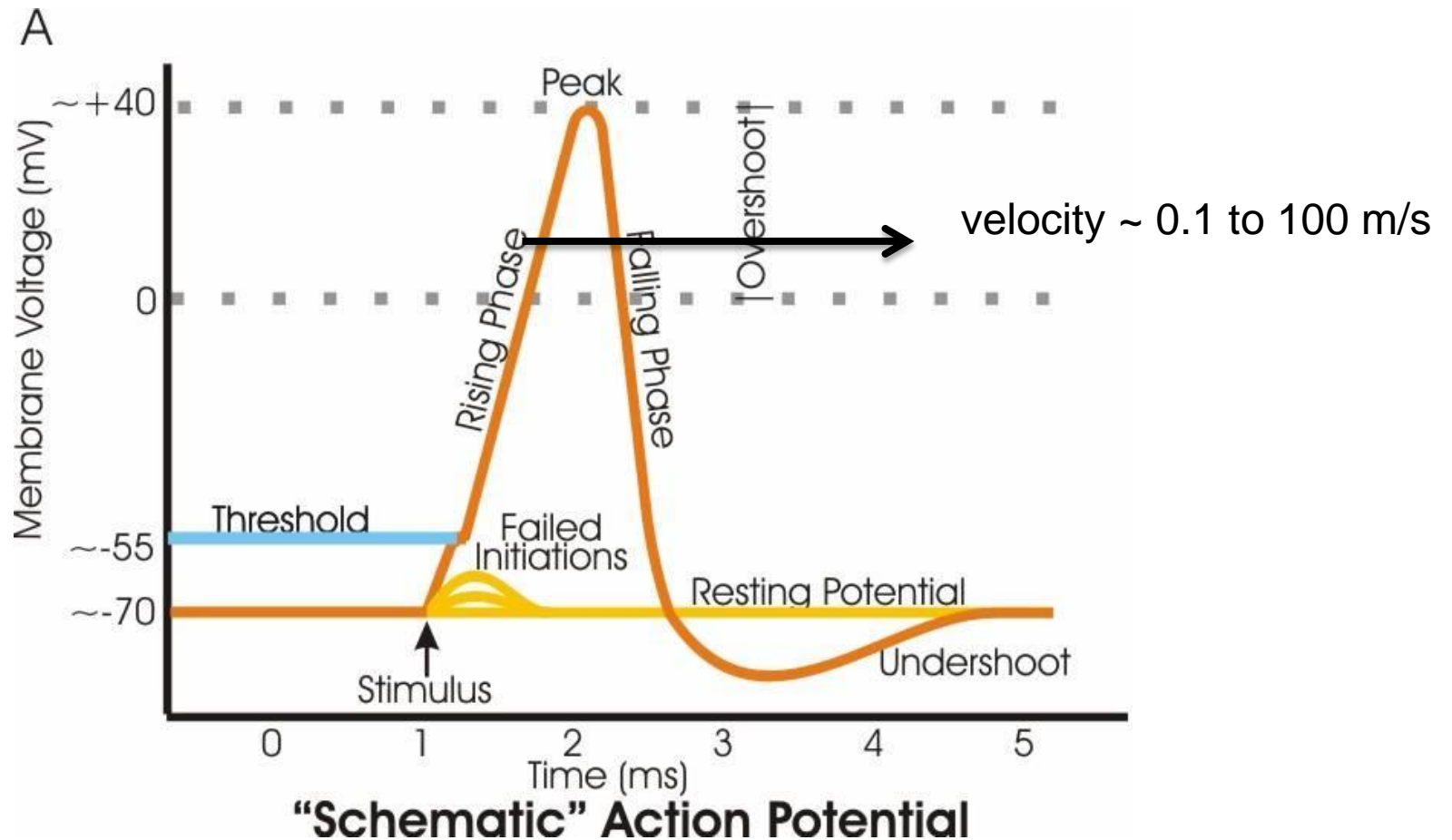

If the membrane potential of a patch of membrane goes above threshold then a propagating pulse is generated that does not decay = action potential

Shape is independent of strength of stimulus above threshold

# Moving action potentials:

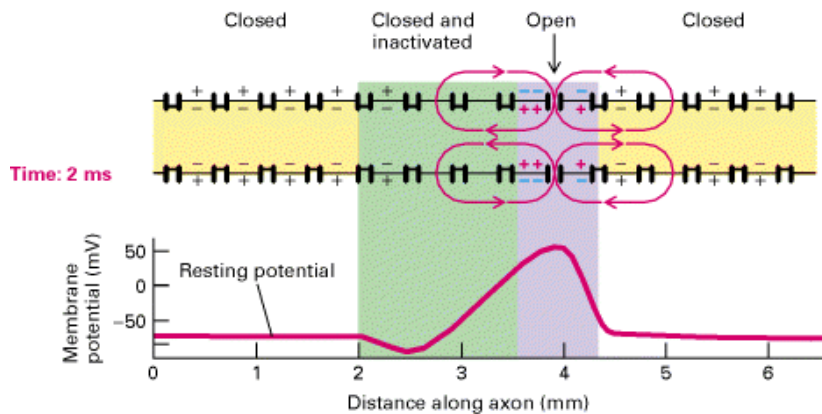
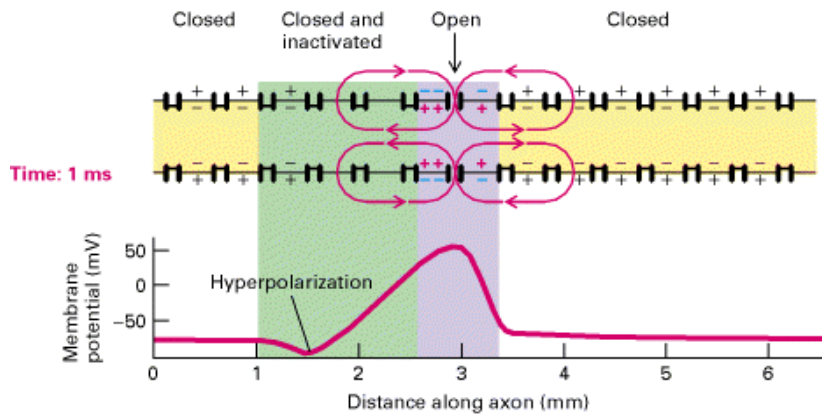
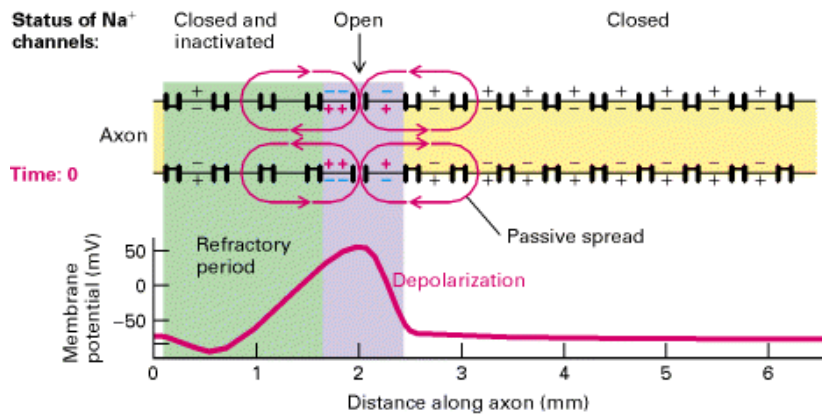

Patches of membrane get coupled by their ion channels

A neighbouring excited patch then excites it's neighbour

Na channels open and the rest potential switches to being strongly positive (the Nernst potential for Na > 0)

## Ionic current:

• Recall Ohm's Law:  $I = \frac{\Delta V}{R}$  or  $I = G \cdot \Delta V$   
↑ conductance

• Flow on ions:

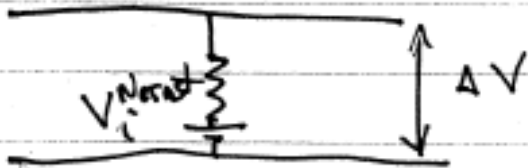

• if  $\Delta V = V_{\text{Nernst}} \rightarrow$  no flow

• Net drop is  $(\Delta V - V_{\text{Nernst}})$   
for ion species  $i$

The flux across the patch for ionic species,  $i$ , is:

$$j_i = g_i (\Delta V - V_i^{\text{Nernst}}) + j_i^{\text{pump}}$$

where  $g_i = 1/R_i$  where  $R_i$  is the resistance of the membrane to that ionic species

# A real membrane patch: membrane capacitance

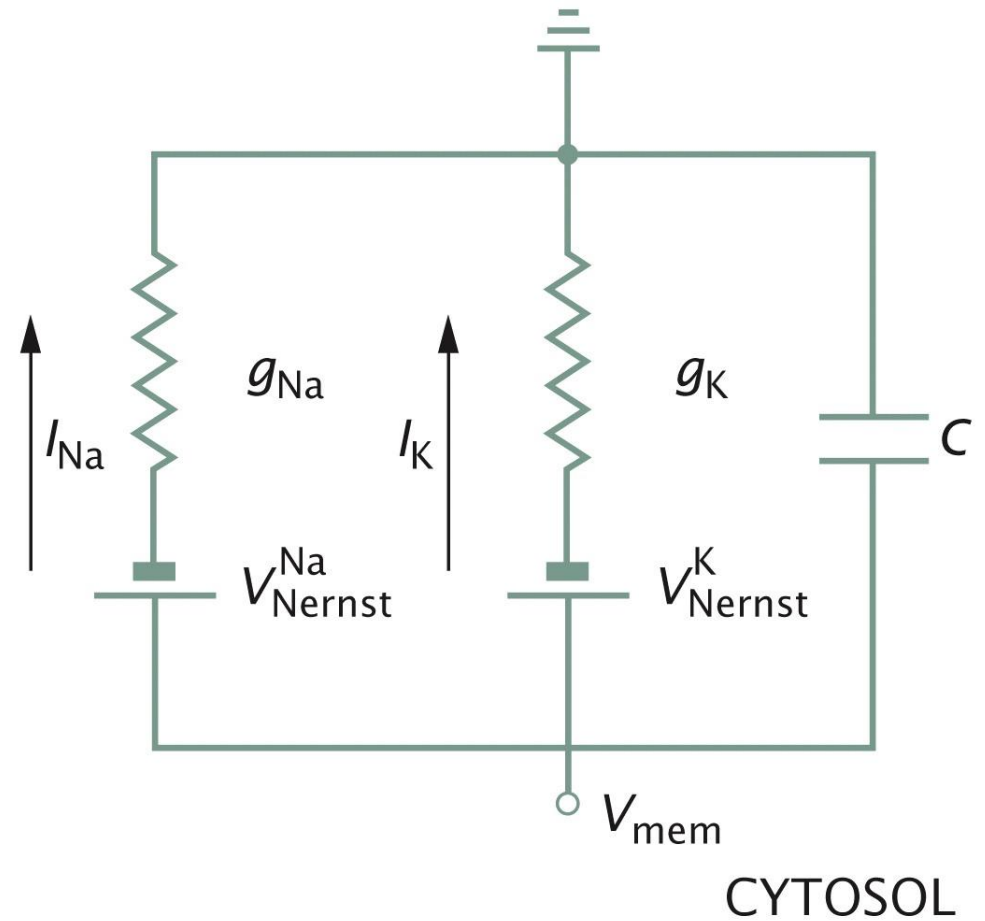
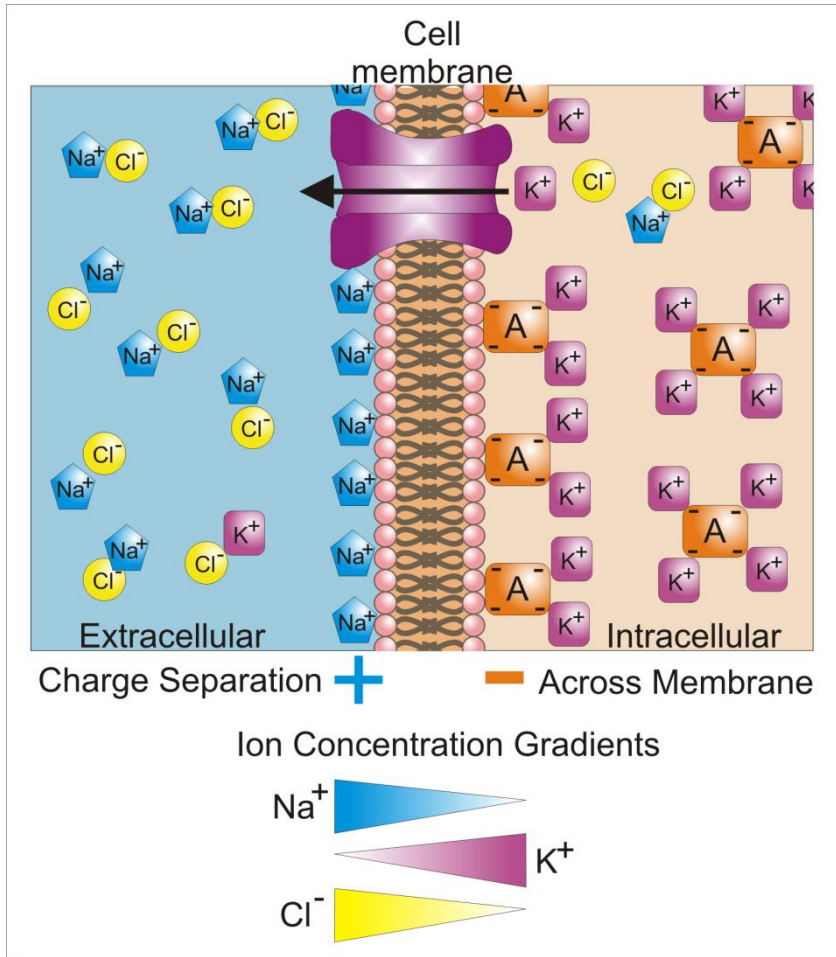

Figure 17.11 Physical Biology of the Cell, 2ed. (© Garland Science 2013)

If we consider the charge distribution across the membrane, it is like a parallel plate capacitor, with +/- q on the outside/inside respectively. So a patch of membrane is an RC-circuit = a resistor + a capacitor



What is a capacitor?



Capacitors store charge. No charge actually flows through them.

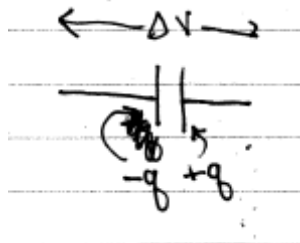

A voltage across a capacitor causes equal and opposite charge to build up on either side of the capacitor

## Membrane capacitance:

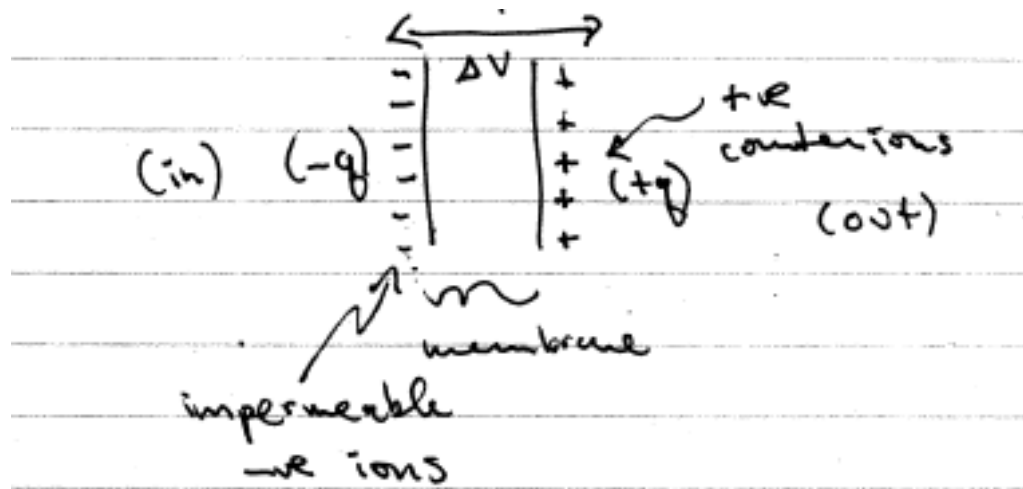

The  $\Delta V$  across the membrane sets up  $-q$  inside and a  $+q$  outside

How much charge is there given a certain voltage difference?

1st year physics:

$$q = C(\Delta V)$$

Capacitors store charge and can produce currents to compensate if the voltage changes - how does this happen?

## Capacitive current:

Consider changing the voltage slightly across a capacitor, what will happen?

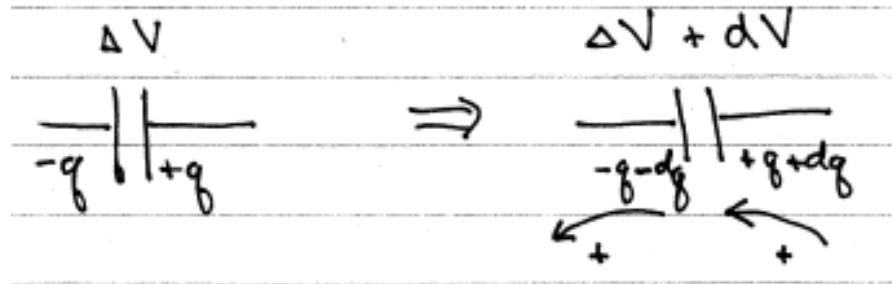

With the additional voltage, more charge  $dq = C dV$  is added/subtracted from the two sides of the capacitor. So the charge flows in one side and flows out the other

If the voltage change happens over a certain time,  $dt$ , then this amount of charge has moved in the system  $I = dq/dt$

$$\frac{dq}{dt} = I = C \frac{d(\Delta V)}{dt}$$

So if there is a time varying potential, a capacitive current will be generated

For axons, a time dependent stimulus will generate an additional capacitive current that must get included in our analysis

# Circuit diagram for the axon

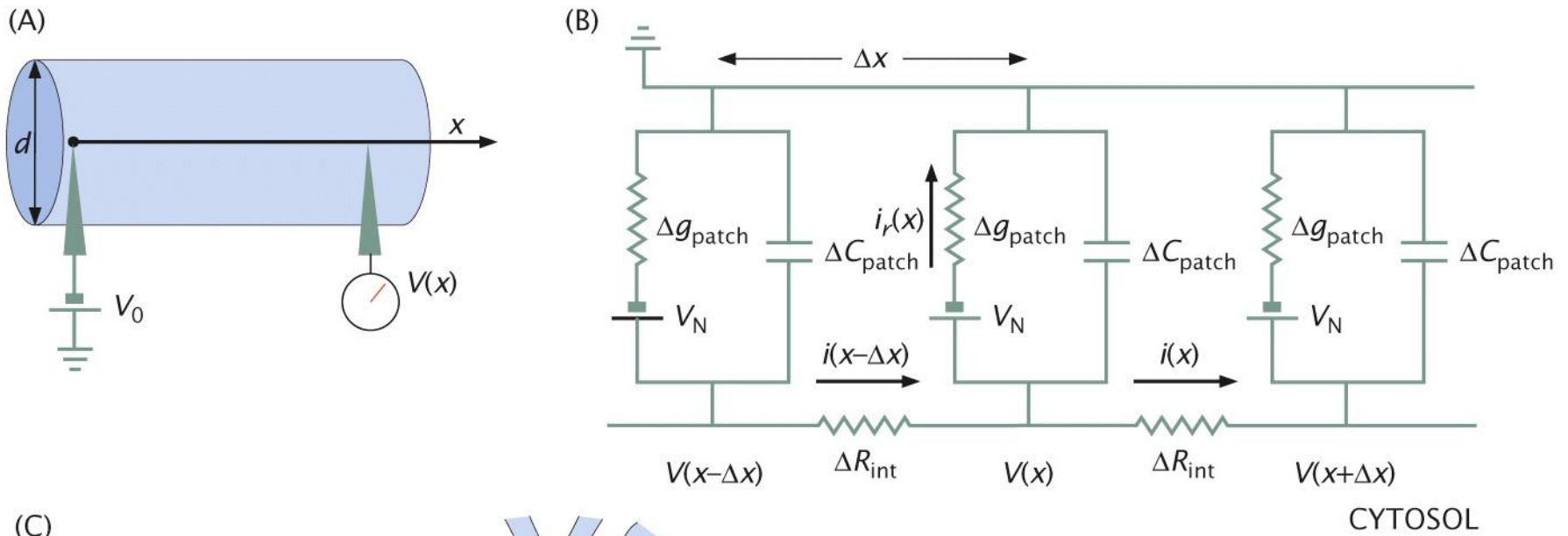

Consider each patch to be linked

There is now a resistance down the axon,  $\Delta R_{int}$

Each patch at position,  $x$ , has it's own membrane potential,  $V(x)$

There is now a current across the membrane and a small current along it

Figure 17.18 Physical Biology of the Cell, 2ed. (© Garland Science 2013)

## Circuit analysis:

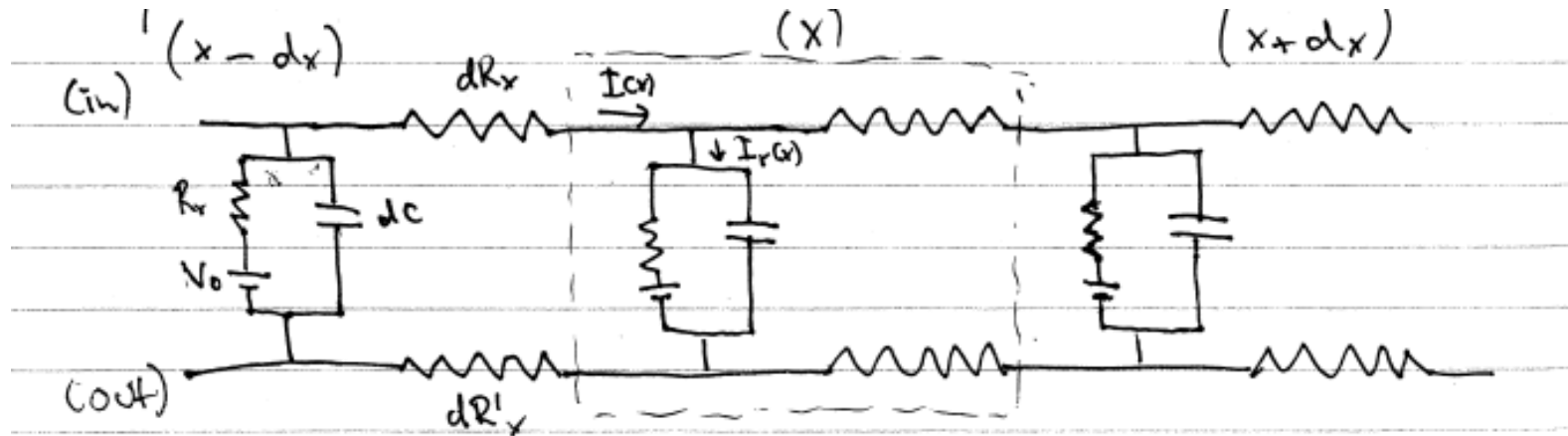

We simplify our system by just considering the flow of all ions lumped together

$V_0$  is the steady-state rest potential for our combined system

Here  $dR_x$  and  $dR'_x$  represent the resistance to current flow along the axon both inside and outside the cell respectively

## Applying Kirchoff's laws:

Since no charge can pile up anywhere, the current in = current out

or Axial current = radial current

$$\text{Axial current: } I_{\text{axial}} = I_x(x) - I_x(x+dx) = -\frac{dI_x}{dx} dx$$

$$\text{Radial current: } I_r(x) = (I_{\text{ohm}}(x) + I_{\text{cap}}(x)) dx$$

↑ capacitance

$$= \left( \frac{V - V_0}{R_R} + c \frac{dV}{dt} \right) dx$$

Now the axial current can be written as:

$$I_x(x) = - \frac{(V(x+dx) - V(x))}{dR_x} = - \frac{V(x+dx) - V(x)}{dx} \frac{1}{\frac{R}{l}} \leftarrow \text{resistance / length}$$
$$= -\frac{1}{\frac{R}{l}} \frac{dV}{dx}$$

## Membrane voltage equation: Cable equation

Equating the axial and radial currents

$$\text{So } I_{\text{axial}} = I_r$$

$$\Rightarrow \frac{1}{2} \frac{d^2 V}{dx^2} = \frac{(V - V_0)}{R_p} + C \frac{dV}{dt}$$

$$\text{let } \tau = R_p C \quad \& \quad \lambda = \sqrt{R_p / \frac{1}{2}} = \lambda \quad v = V - V_0$$

$$\Rightarrow \lambda^2 \frac{d^2 v}{dx^2} - \tau \frac{dv}{dt} = v \quad \equiv \text{cable eqn}$$

The cable equation gives the spatial and temporal dynamics of the membrane potential ASSUMING that this circuit captures all the biology of the membrane

We will see that this equation does not allow for a propagating wave  $\rightarrow$  so it's not a complete description of the real biology

## Solution to the cable equation:

---

Try a solution of the following form:

let  $w(x,t) = e^{t/\tau} v(x,t)$  & sub into cable eqn

$$\Rightarrow \frac{\lambda^2}{\tau} \frac{d^2 w}{dx^2} = \frac{dw}{dt} \equiv \text{Diffusion eqn for } w$$

Recall: for diffusion,  $D \frac{d^2 c}{dx^2} = \frac{dc}{dt}$

and that the solution of the diffusion equation always had spreading and decaying solutions for the concentration  $\rightarrow$  can not get waves out of the diffusion equation

So there are no waves or action potentials from this model

However,  $v(x,t) = e^{-t/\tau} w(x,t)$  is a decaying and spreading solution which is what is seen for weak stimulus, below threshold

So the cable equation is valid for weak stimulus, in the electrotonus regime

So what biology leads to propagating waves? what needs to get added to our equation?



## Solution to cable equation:

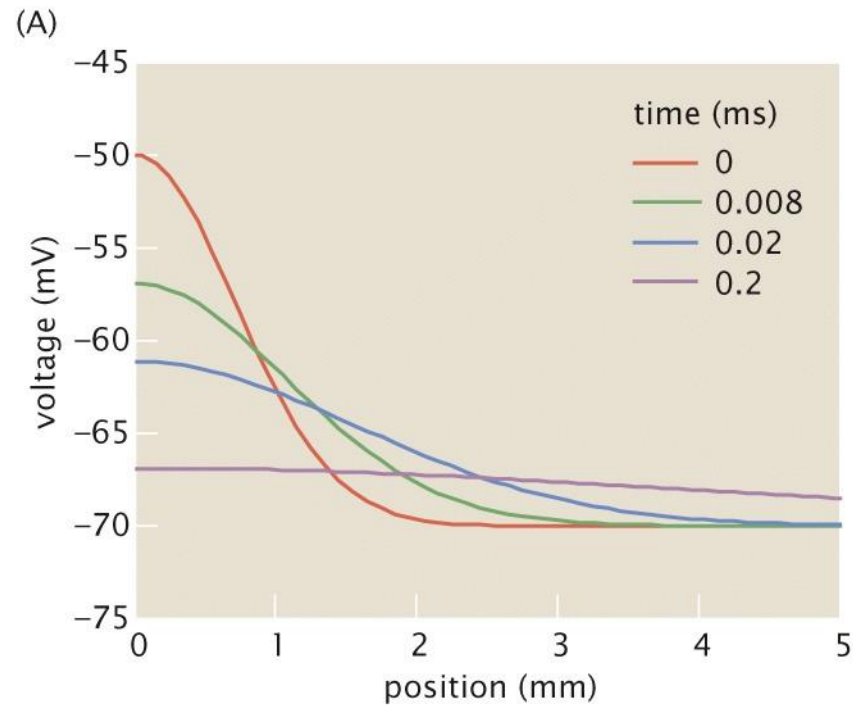

Figure 17.20 Physical Biology of the Cell, 2ed. (© Garland Science 2013)

The plot above shows the solution for the membrane potential as a function of position at different times given that there was an initial weak pulse

## Voltage gated ion channels:

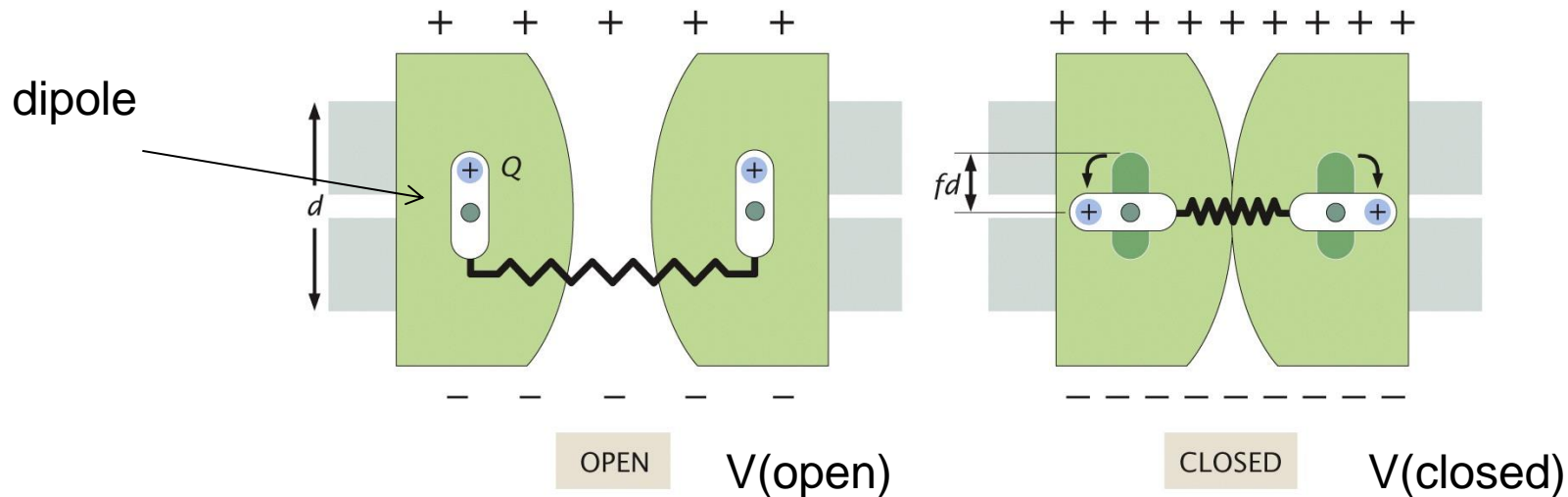

Figure 17.6 Physical Biology of the Cell, 2ed. (© Garland Science 2013)

There exist channels in the membrane that open and close in response to voltage

So the membrane conductance for certain species is now voltage dependent,  $g_i = g_i(V)$

So in the cable equation, we now have a non-linear equation that depends on voltage  $\rightarrow$  non-linear equations admit multiple solutions  $\rightarrow$  ON or OFF

## Channel opening probability:

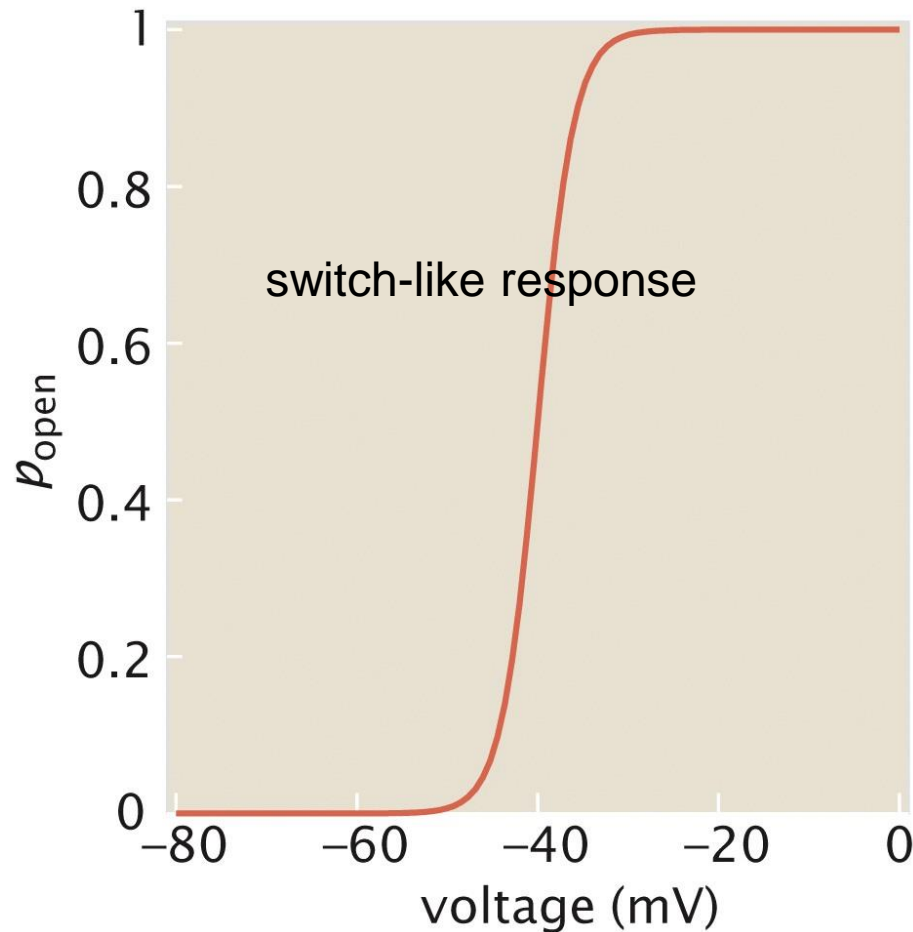

Figure 17.7 Physical Biology of the Cell, 2ed. (© Garland Science 2013)

Let's assume a 2 state system, the channel is open or it is closed

When it is closed, it has energy  $E_c$

When it is open it has energy  $E_o + d V$

From Boltzmann, the probability of being open is:

$$p(open) = \frac{\exp\left(-\frac{E_o + d V}{kT}\right)}{\exp\left(-\frac{E_c}{kT}\right) + \exp\left(-\frac{E_o + d V}{kT}\right)} = \frac{1}{1 + \exp\left(-\frac{d V - \Delta E}{kT}\right)}$$

# Intro to Hodgkin-Huxley

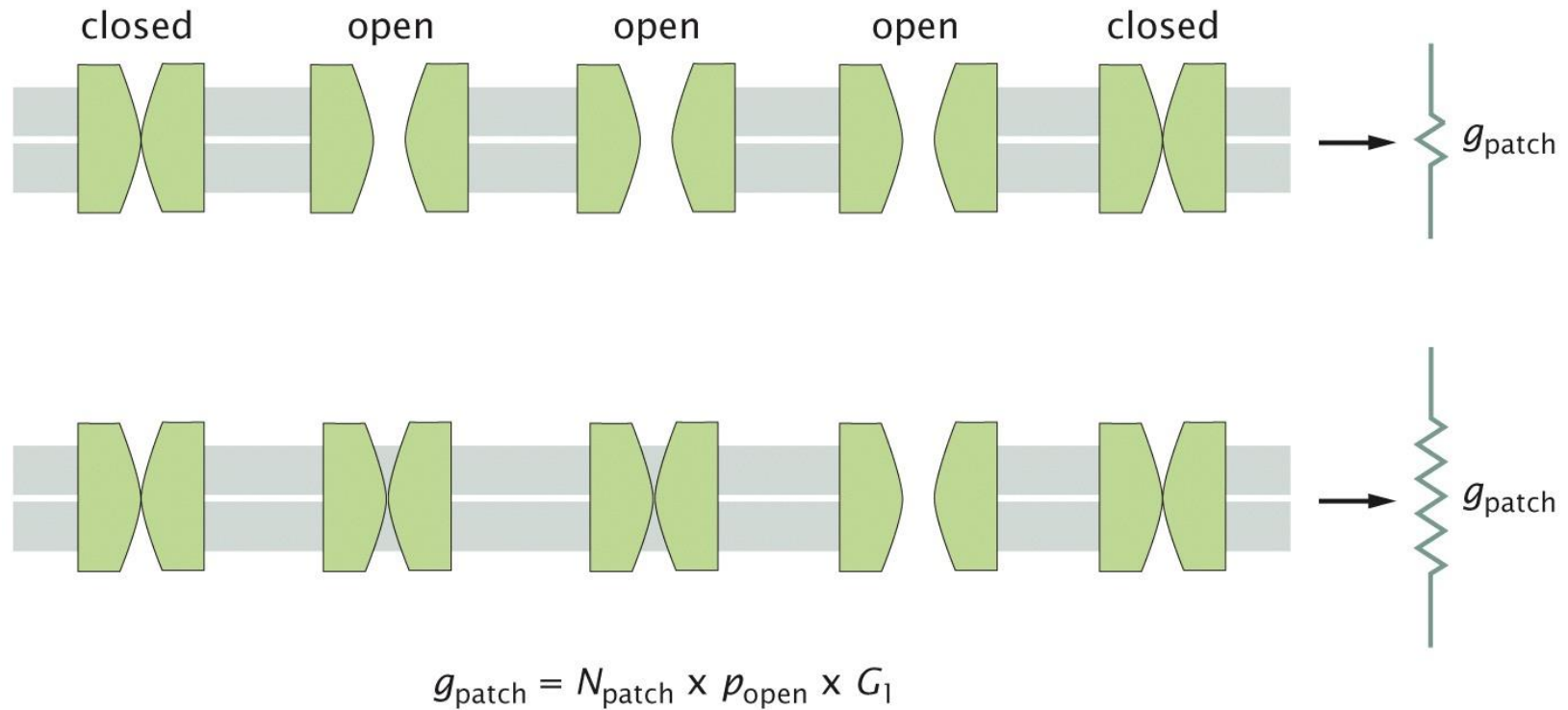

Figure 17.14 Physical Biology of the Cell, 2ed. (© Garland Science 2013)

The key is that each channel now has a probability of being open

In each patch there will be a dynamic number of channels open

Hodgkin and Huxley wrote down dynamic equations for the # of open channels

So there are coupled equations for  $V(x,t)$  as well as for  $N(x,t)$  – the # of open channels

## Positive feedback and cooperativity:

The voltage sensitivity of the Na channels, acts as positive feedback

A depolarizing membrane (voltage is increasing) causes the channels to open bringing more Na into the cell

This then causes the membrane to depolarize more → to more channels open → to more Na being brought into the cell.

This is positive feedback, and along with the cooperative response of the channel can lead to switching behaviour. i.e. the patch is either at rest or activated

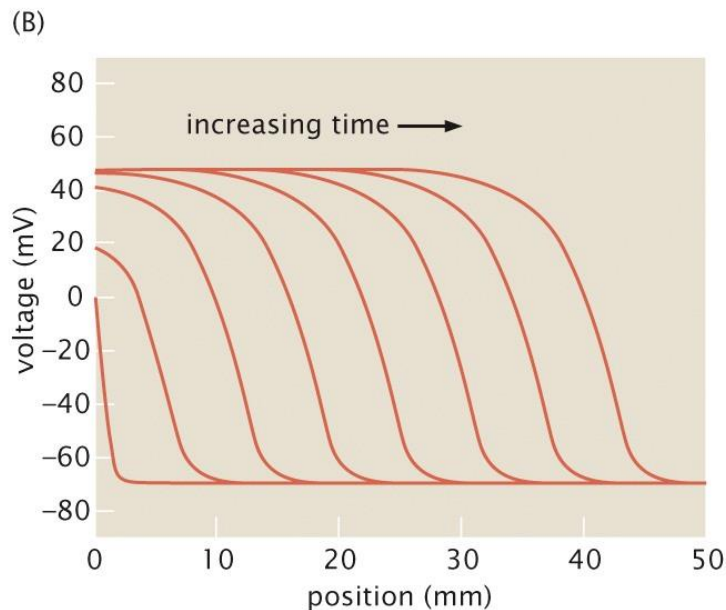

Solution for  $V(x,t)$  including positive feedback into the problem

The idea is:

$$I_i = g_i(\Delta V) (\Delta V - V_i^{Nernst})$$

## A simple non-linear voltage response:

simple model:  $g_{Na^+}(V) = g_{Na^+}^0 + BV^2$

→ conductance increases with voltage

Result:

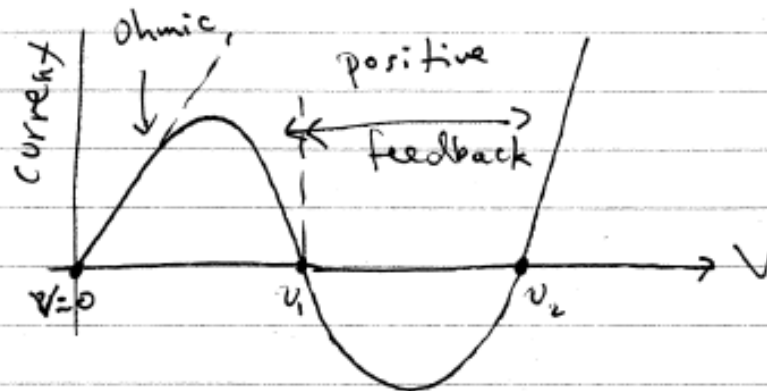

Below  $v_1$ , the stable point is the rest potential  $V - V_0 = 0$

whereas above  $v_1$  the system moves to the other stable point which is at  $v_2$   
→ stable +ve voltage

# The biology of it all: synapses

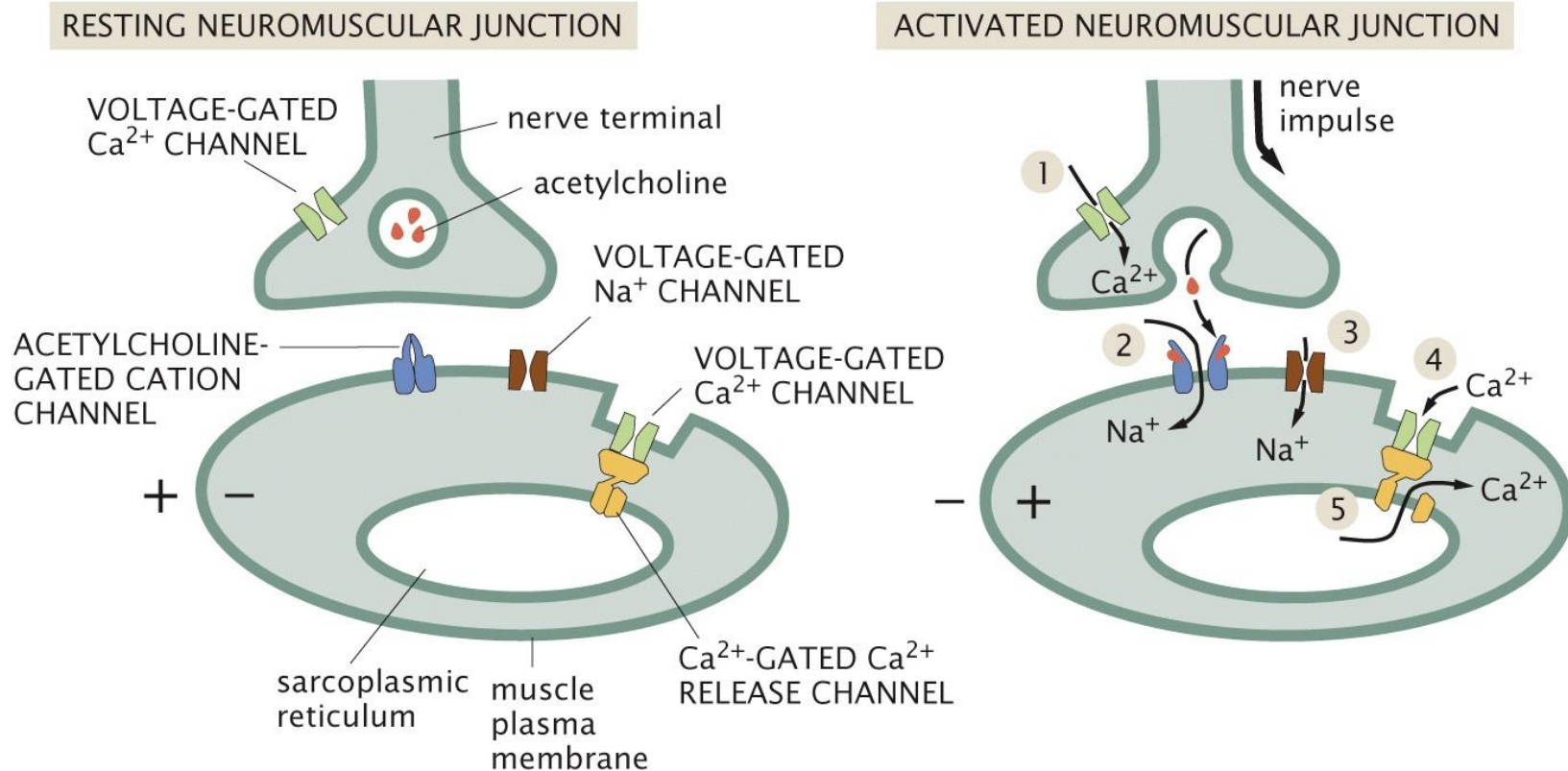

Figure 17.10 Physical Biology of the Cell, 2ed. (© Garland Science 2013)

- 1) The action potential opens up Ca channels in the pre-synaptic cell (axon)
- 2) Neurotransmitters cross the synapse, polarize the post-synaptic cell
- 3) This opens up voltage sensitive Na channels → opening of other voltage sensitive channels.

## Example: contracting muscle fibres

---

... Let's watch a youtube clip on how a motor neuron talks to a muscle cell

So the action potential is critical not only for neuron communication, but for signalling to other cells like muscle tissue



## Summary:

---

The pumps keep axons out of equilibrium

Depolarizing/stimulating a membrane leads to a voltage pulse:

    this pulse can either decay and diffuse away

    or propagate indefinitely down the axon at a fixed speed

Derived the cable equation combining the ohmic and capacitive current of membrane

Cable equation does not admit propagating waves – missing biology

Missing biology = voltage activated channels

These channels generate positive feedback and admit the possibility of a bistable system

... now on to information processing in the nervous system